

TEAC



SERVICE MANUAL

AG-7D

AV Digital Home Theater Receiver



CONTENTS

1 SPECIFICATIONS	2
2 ADJUSTMENTS	3
3 EXPLODED VIEWS AND PARTS LIST	4
4 PC BOARDS AND PARTS LIST	7
5 INCLUDED ACCESSORIES	22

NOTES

- PC boards shown are viewed from parts side.
- The parts with no reference number or no parts number in the exploded views are not supplied.
- As regards the resistors and capacitors, refer to the circuit diagrams contained in this manual.
- ⚠ Parts marked with this sign are safety critical components. They must be replaced with identical components - refer to the appropriate parts list and ensure exact replacement.
- Parts of [] mark can be used only with the version designated.
[E]:EUROPE [A]:AUSTRALIA [CN]:CHINA [K]:KOREA

1 SPECIFICATIONS

Amplifier Section

Output Power100 W + 100 W
(Stereo, 0.2 % THD, 20 Hz to 20 kHz, 6 Ω)
120W + 120W (6 Ω , JEITA)

Surround Output Power125 W per channel
(0.7 % THD, 1 kHz, 6 Ω , only one channel driven)
160 W per channel (6 Ω , JEITA)

Total Harmonic Distortion0.09 % (at 95 W, 1 kHz, 6 Ω)

Audio Input Sensitivity/Impedance*LINE: 200 mV/47 k Ω

Output Level/Impedance (TAPE REC)200 mV / 2.2 k Ω

Frequency Response*LINE: 20 Hz to 50 kHz, +0 / -3 dB

Signal-to-Noise Ratio*LINE: 90 dB (IHF-A)

Tone ControlBASS: \pm 10 dB at 100 Hz
TREBLE: \pm 10 dB at 10 kHz

Digital Audio Section

Sampling Frequency32 kHz, 44.1 kHz, 48 kHz, 96 kHz

Digital Input LevelCOAXIAL (75 Ω): 0.5 Vp-p
OPTICAL (660nm): -15 dBm to -21 dBm

Video Section

S-Video output

Y (luminance) - Output level1 Vp-p (75 Ω)

C (color) - Output level.....286 mVp-p (75 Ω)

JacksS-VIDEO jack

Video output

Output level1 Vp-p (75 Ω)

JacksRCA jack

Component video output (Y, P_B, P_R)

Y-Output level.....1.0 Vp-p (75 Ω)

P_B, P_R-Output level0.7 Vp-p (75 Ω)

JacksRCA jacks

FM Tuner Section (Without notes 100.1 MHz, 65 dBf)

Tuning Range87.5 MHz to 108.0 MHz (50 kHz steps)

Total Harmonic Distortion (1 kHz)Mono: 0.5%
Stereo: 0.8%

Frequency Response30 Hz to 15 kHz, \pm 3 dB

Stereo Separation (1 kHz).....40 dB

Signal-to-Noise RatioMono: 70 dB
Stereo: 65 dB

AM Tuner Section

Tuning Range522 kHz to 1,611 kHz (9 kHz steps)

Usable Sensitivity500 μ V/m

Total Harmonic Distortion1.5% at 100 dB/m

Signal-to-Noise Ratio40 dB at 100 dB/m

General

Power RequirementsAC 220 V, 50 Hz (China/Korea model)
AC 230 V, 50 Hz (Europe/Australia model)

Power Consumption250 W (STANDBY : 3 W)

AC Outletswitched x 1
(except Australia model, total 100 W max.)

Dimensions (W x H x D)435 x 143 x 372 mm

Weight (net)10.4 kg

Standard Accessories

Power Cord x 1

AM Loop Antenna x 1

FM T-type Antenna x 1

FM Matching Transformer x 1

Remote Control Unit (UR-426) x 1

Battery (AAA, R03, UM-4) x 2

Owner's Manual x 1

* LINE means CD, TAPE, VIDEO.

- Design and specifications are subject to change without notice.
- Weight and dimensions are approximate.

2 ADJUSTMENTS

2-1 Adjustment Locations

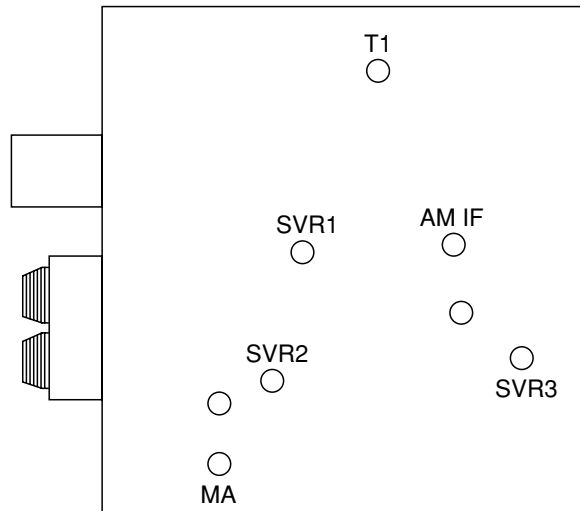

2-2 AM Adjustment

ITEM	SIGNAL GENERATOR SETTING		FREQUENCY SETTING	ADJUSTMENT POINTS	ADJUST FOR
	SIGNAL	OUTPUT			
1. RF Tracking	400Hz 30% modulation	58dBu	603kHz 1404kHz	MA coil	Output level is maximum. 603kHz, 1404kHz should be confirmed repeatedly.
2. IF Tracking	400Hz 30% modulation	58dBu	603kHz	AM IF coil	Output level is maximum.
3. Auto Stop Level	400Hz 30% modulation	60dBu	603kHz	SVR3	TUNED indicator lights.

2-3 FM Adjustment

ITEM	SIGNAL GENERATOR SETTING		FREQUENCY SETTING	ADJUSTMENT POINTS	ADJUST FOR
	SIGNAL	OUTPUT			
1. Stereo Distortion	1kHz Main: 90% Pilot: 10%	60dBu	98.1MHz	T1 coil	Distortion is minimum.
2. Stereo Separation	1kHz Main: 90% Pilot: 10%	60dBu	98.1MHz	SVR2	Separation is maximum.
3. Auto Stop Level	1kHz 75 kHz deviation	19dBu	98.1MHz	SVR1	TUNED indicator lights.

3 EXPLODED VIEWS AND PARTS LIST

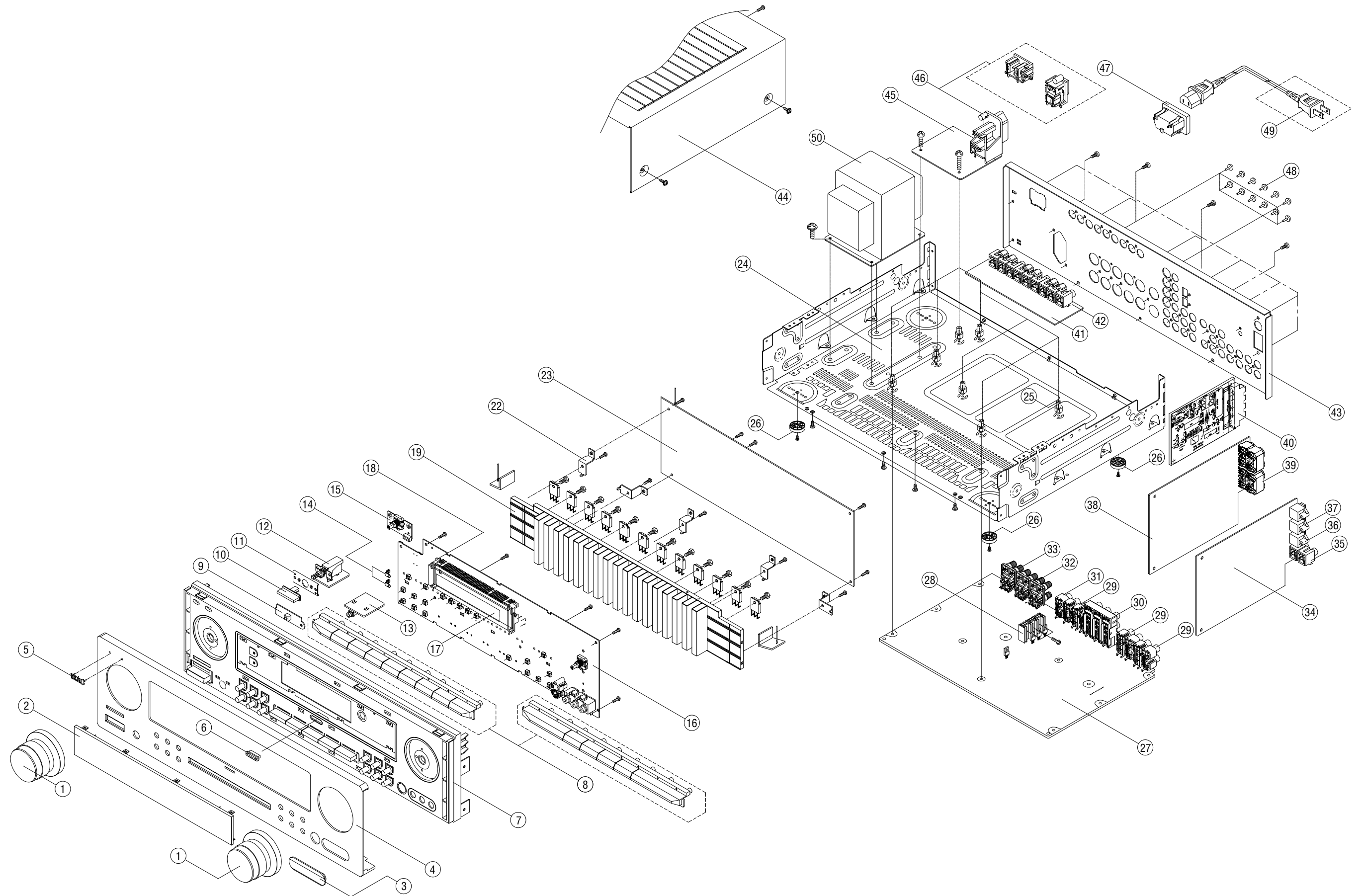

EXPLODED VIEW LIST

REF. NO.	PARTS NO.	DESCRIPTION	REMARKS
1	5088210788000Z 5088210788010Z	KNOB ASSY [E, A, K] KNOB ASSY [CN]	
2	5077210973020	WINDOW, DISPLAY	
3	4317211141000 4317211141010	COVER, RCA [E, A, K] COVER, RCA [CN]	
4	3067211198050 3067211198040 3067211198080	PANEL, FRONT [E] PANEL, FRONT [A, K] PANEL, FRONT [CN]	
5	5630210328000 5630210328010	BADGE [E, A, K] BADGE [CN]	
6	5160210093000	INDICATOR, LED	
7	3417210091000 3417210091010	BODY [E, A, K] BODY [CN]	
8	5097211981020 5097211991020 5097211991040	BUTTON, 9KEY-RDS [E] BUTTON, 4KEY [A, K] BUTTON, 4KEY [CN]	
9	7028063233010	ST-BY SW PCB ASSY	
10	5097211971000 5097211971010	BUTTON, POWER [E, A, K] BUTTON, POWER [CN]	
11	4010210876000	BRACKET, POWER	
12	7028063234010	POWER SW PCB ASSY	
13	7028063236010 7028063236020	HP PCB ASSY [E, A, K] HP PCB ASSY [CN]	
14	5160040643010	INDICATOR, STAND-BY	
15	7028063212010	MULTI PCB ASSY	
16	7028063211040 7028063211020 7028063211060	FRONT PCB ASSY [E] FRONT PCB ASSY [A, K] FRONT PCB ASSY [CN]	
17	K530125000010	DISPLAY, FLT HNA-12MM50	
18	4320210091010	HOLDER, FLT	
19	2120210678000	HEAT SINK	
22	4010056906010	BRACKET, HEAT SINK	
23	7028063261010	AMP PCB ASSY	
24	3200211166000	CHASSIS, MAIN	
25	4300040561010	SPACER, KNOB	
26	4007040241040 4007040241050	FOOT [E, A, K] FOOT [CN]	
27	7028063251070 70280632510D0 7028063251080	MAIN PCB ASSY [E] MAIN PCB ASSY [A, CN] MAIN PCB ASSY [K]	
28	2120210748020	HEAT SINK	
29	G602405B0400Y	TERMINAL, RCA 4PIN	
30	G607902AA101Y	TERMINAL, RCA 9PIN	
31	G601207E0200Y	TERMINAL, RCA 2PIN	
32	G614801A1400Y	TERMINAL, BOARD SCREW 8P	
33	G612405E1200Y	TERMINAL, BOARD SCREW 4P	
34	7028063241020	DSP PCB ASSY	
35	G601020130100	TERMINAL, RCA 2PIN	
36	E100116500010	MODULE, OPTICAL TRANSMITTER	
37	E100116500020	MODULE, OPTICAL RECEIVER	
38	7028063221040 7028063221020	VIDEO PCB ASSY [E, A, CN] VIDEO PCB ASSY [K]	
39	G601802002010	TERMINAL, RCA 2PIN	

EXPLODED VIEW LIST

REF. NO.	PARTS NO.	DESCRIPTION	REMARKS
40	E903141130010	TUNER, FM/AM KST-MB014MA1-13 [E, A]	
	E903111300010	TUNER, FM/AM KST-MB001MA1-13 [CN]	
	E903011300010	TUNER, FM/AM KST-MB001MA0-13S [K]	
41	7028063232020	COMPONENT PCB ASSY	
42	6606030164010	TERMINAL, RCA 3PIN	
43	3207211466030	CHASSIS, BACK [E]	
	3207211466060	CHASSIS, BACK [A]	
	3207211466050	CHASSIS, BACK [CN]	
	3207211466040	CHASSIS, BACK [K]	
44	3007210356000	CABINET, TOP [E, A, K]	
	3007210356010	CABINET, TOP [CN]	
45	7028063231050	ST-BY PCB ASSY [E]	
	7028063231080	ST-BY PCB ASSY [A]	
	7028063231070	ST-BY PCB ASSY [CN]	
	7028063231060	ST-BY PCB ASSY [K]	
46	△ G435040110000	SOCKET, POWER RECEPTACLE [E]	
	△ G435000130010	SOCKET, POWER RECEPTACLE [CN]	
	△ G435000160010	SOCKET, POWER RECEPTACLE [K]	
47	△ G430040550010	SOCKET, POWER AC	
48	2410040353010	BUSHING, TERMINAL [E, A, K]	
49	△ L061000000060	CORD, AC [E]	
	△ L068020130010	CORD ASSY [A]	
	△ L061000000040	CORD, AC [CN]	
	△ L061000000050	CORD, AC [K]	
50	△ 8200960610260	POWER TRANS, MAIN 230V [E, A]	
	△ 8200960610270	POWER TRANS, MAIN 220V [CN, K]	
	N712151634810	CABLE, FLAT CARD 15P	
	N712172044810	CABLE, FLAT CARD 17P	
Q204C	J503947F00000	TR, 2SD947F	
Q204FL	J503947F00000	TR, 2SD947F	
Q204FR	J503947F00000	TR, 2SD947F	
Q204SB	J503947F00000	TR, 2SD947F	
Q204SL	J503947F00000	TR, 2SD947F	
Q204SR	J503947F00000	TR, 2SD947F	
Q205C	△ J5032390Y0000	TR, 2SD2390Y	
Q205FL	△ J5032390Y0000	TR, 2SD2390Y	
Q205FR	△ J5032390Y0000	TR, 2SD2390Y	
Q205SB	△ J5032390Y0000	TR, 2SD2390Y	
Q205SL	△ J5032390Y0000	TR, 2SD2390Y	
Q205SR	△ J5032390Y0000	TR, 2SD2390Y	
Q206C	△ J5011560Y0000	TR, 2SB1560Y	
Q206FL	△ J5011560Y0000	TR, 2SB1560Y	
Q206FR	△ J5011560Y0000	TR, 2SB1560Y	
Q206SB	△ J5011560Y0000	TR, 2SB1560Y	
Q206SL	△ J5011560Y0000	TR, 2SB1560Y	
Q206SR	△ J5011560Y0000	TR, 2SB1560Y	

4 PC BOARDS AND PARTS LIST

MAIN PCB (SIDE A)

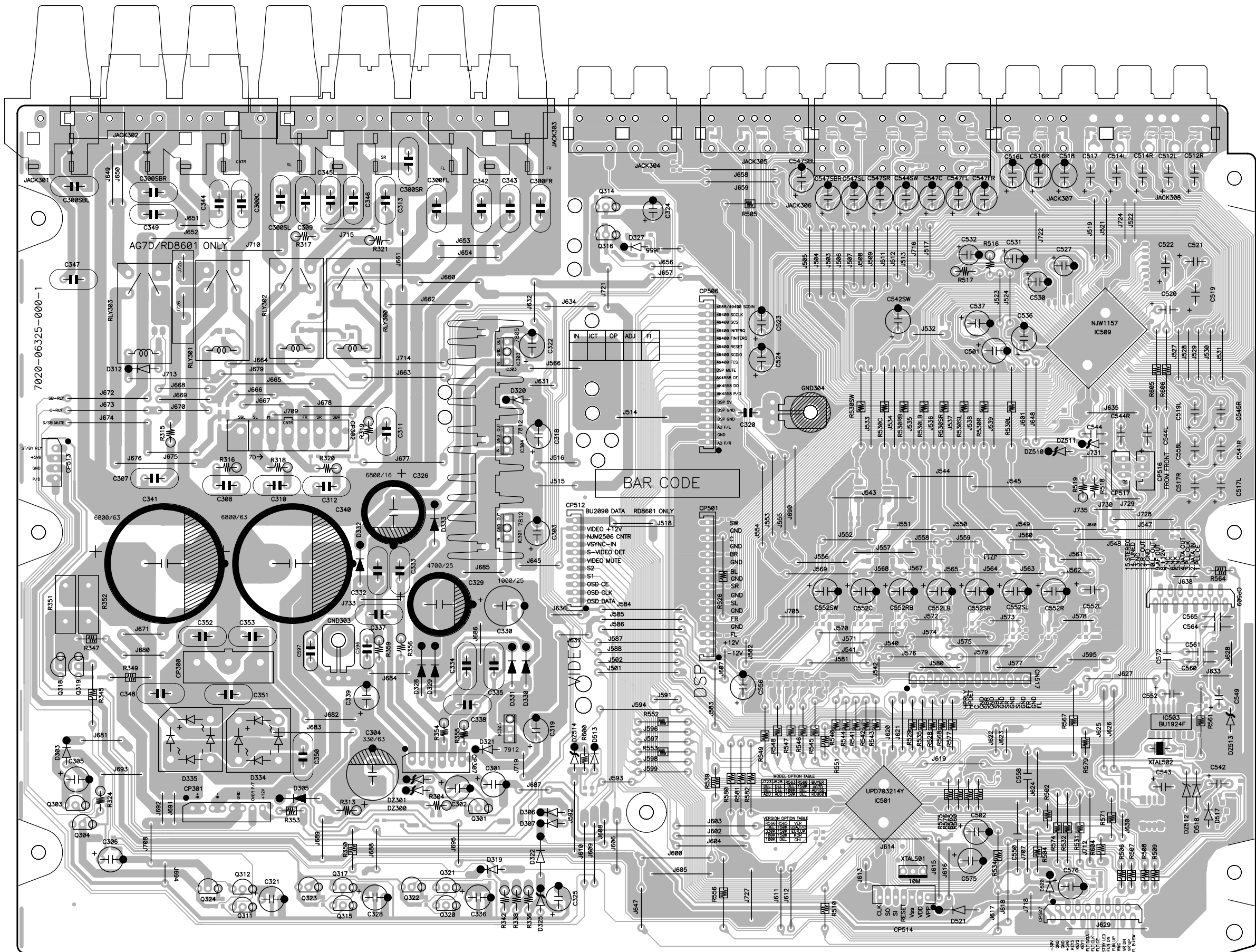

MAIN PCB (SIDE B)

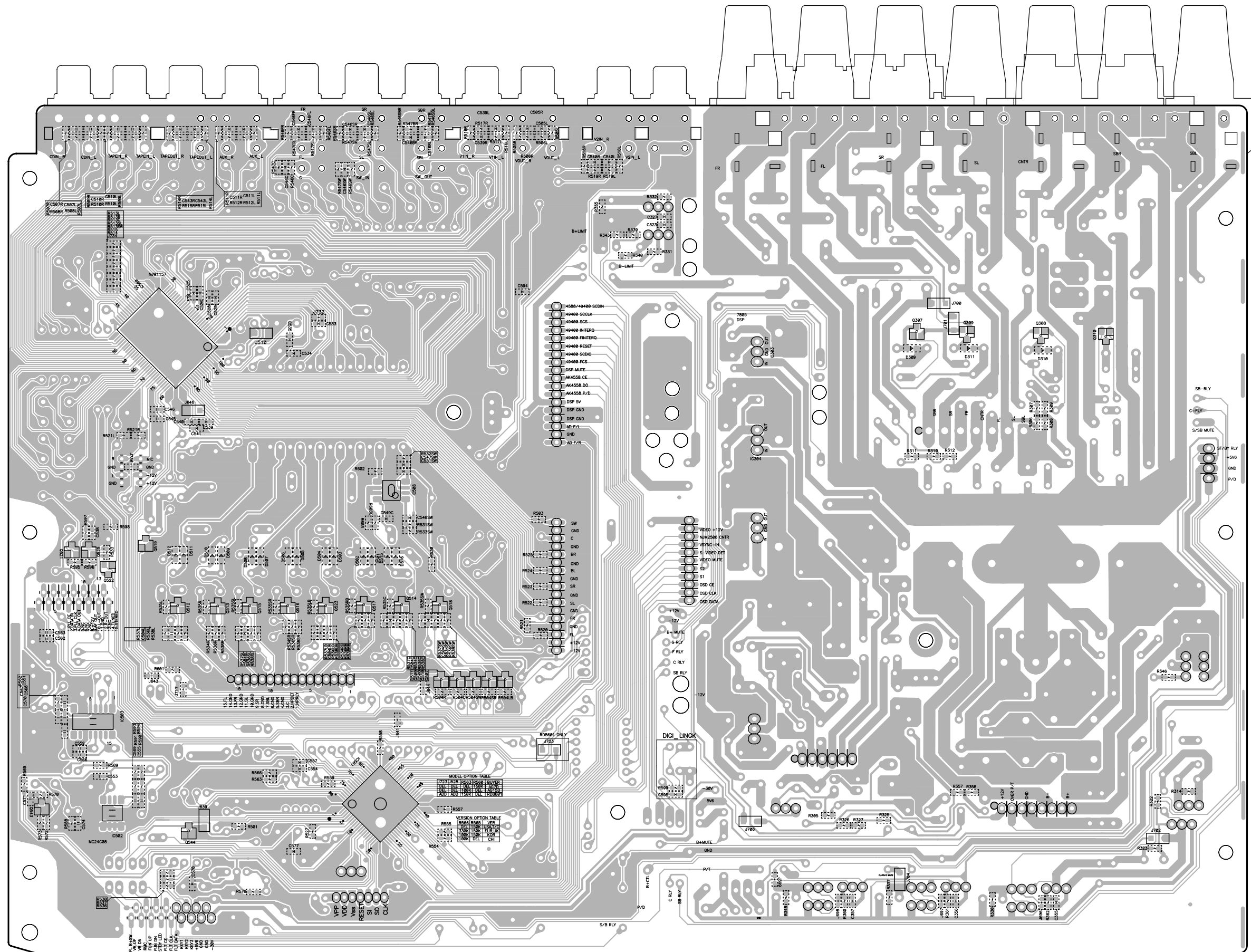

AMP PCB

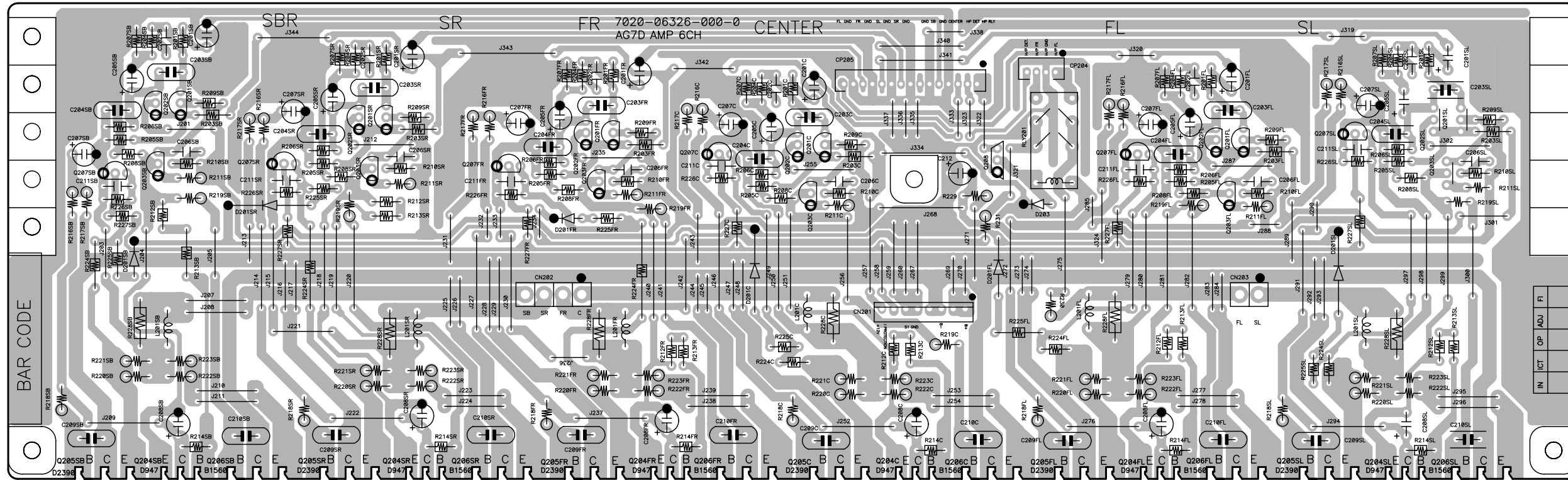

FRONT PCB

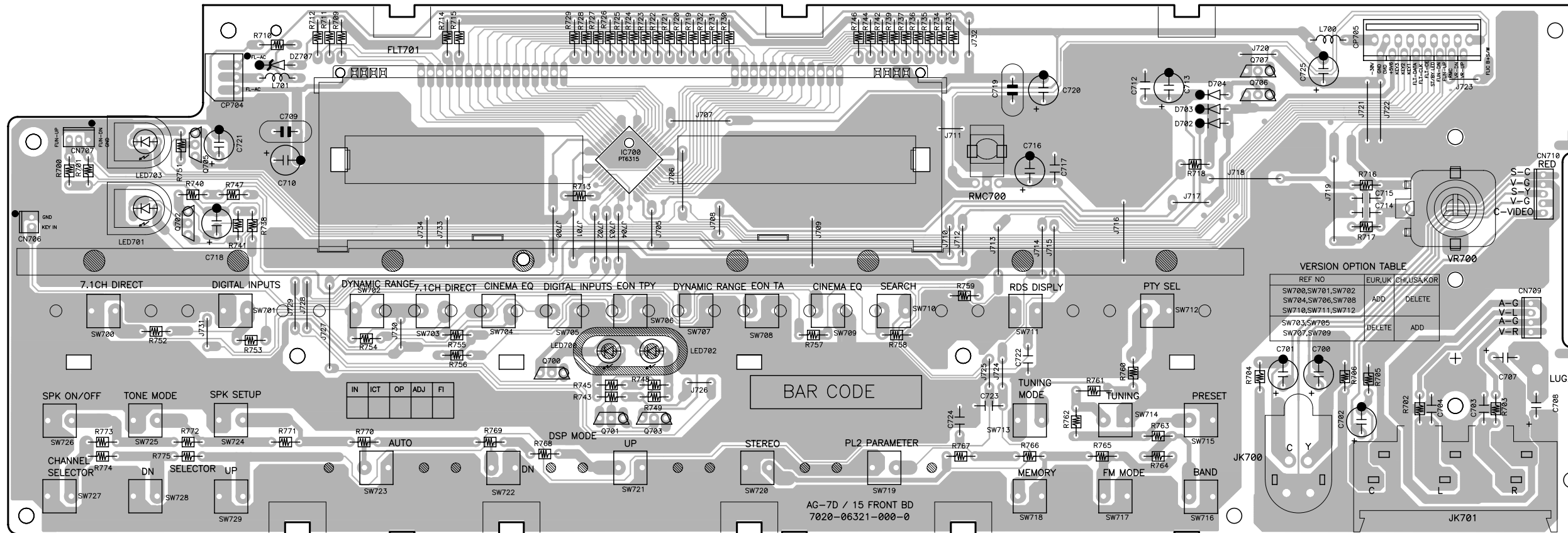

VERSION OPTION TABLE

REF NO	EUR,UK	CH,USA,KOR
SW703,SW701,SW702		DELETE
SW704,SW706,SW708	ADD	
SW710,SW711,SW712		DELETE
SW703,SW705	DELETE	ADD
SW707,SW709		

MULTI PCB

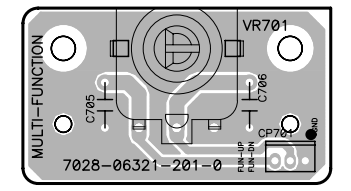

DSP PCB (SIDE A)

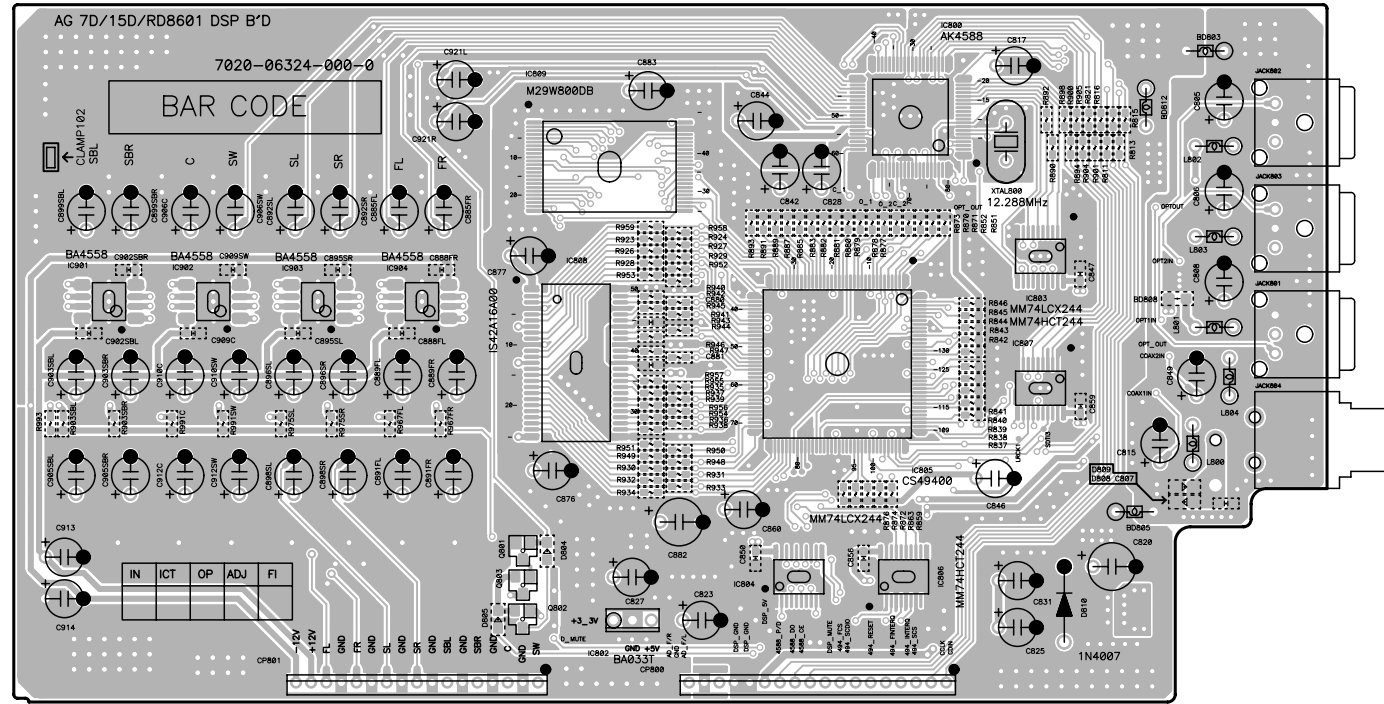

DSP PCB (SIDE B)

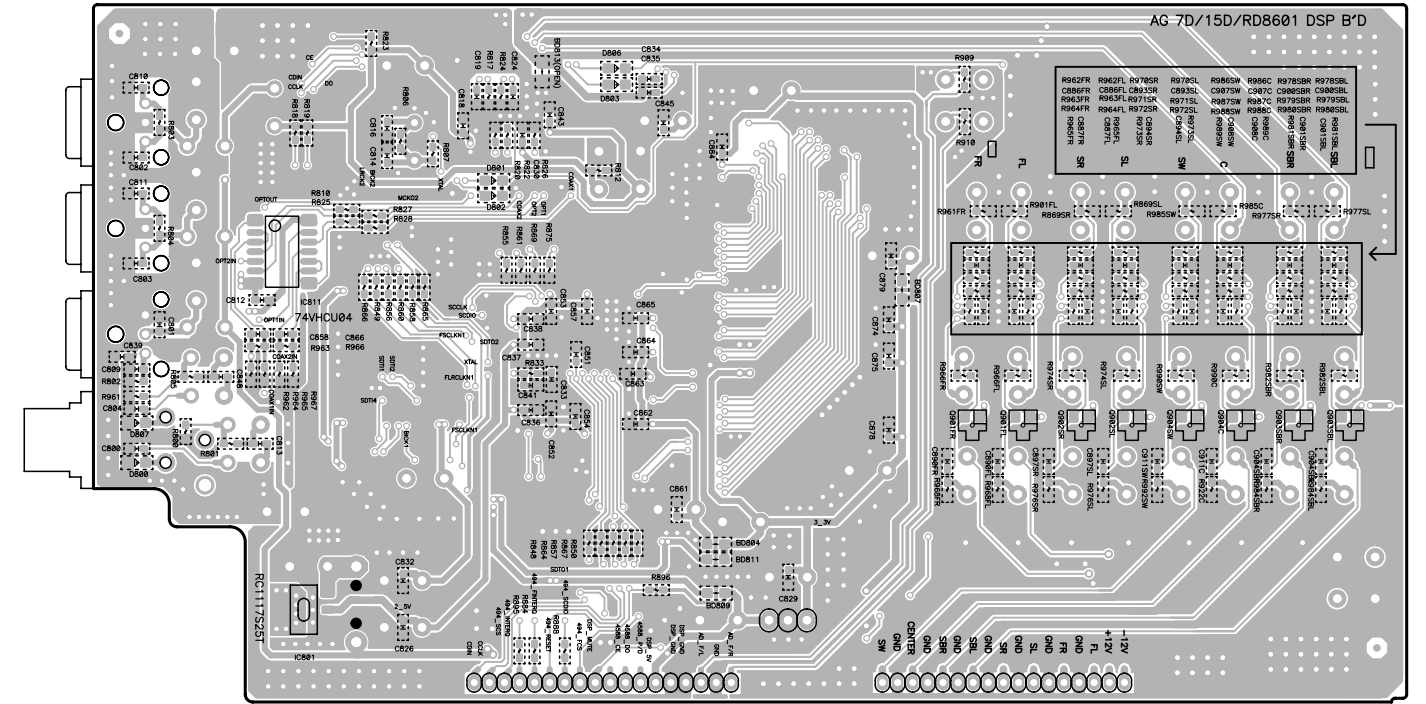

VIDEO PCB (SIDE A)

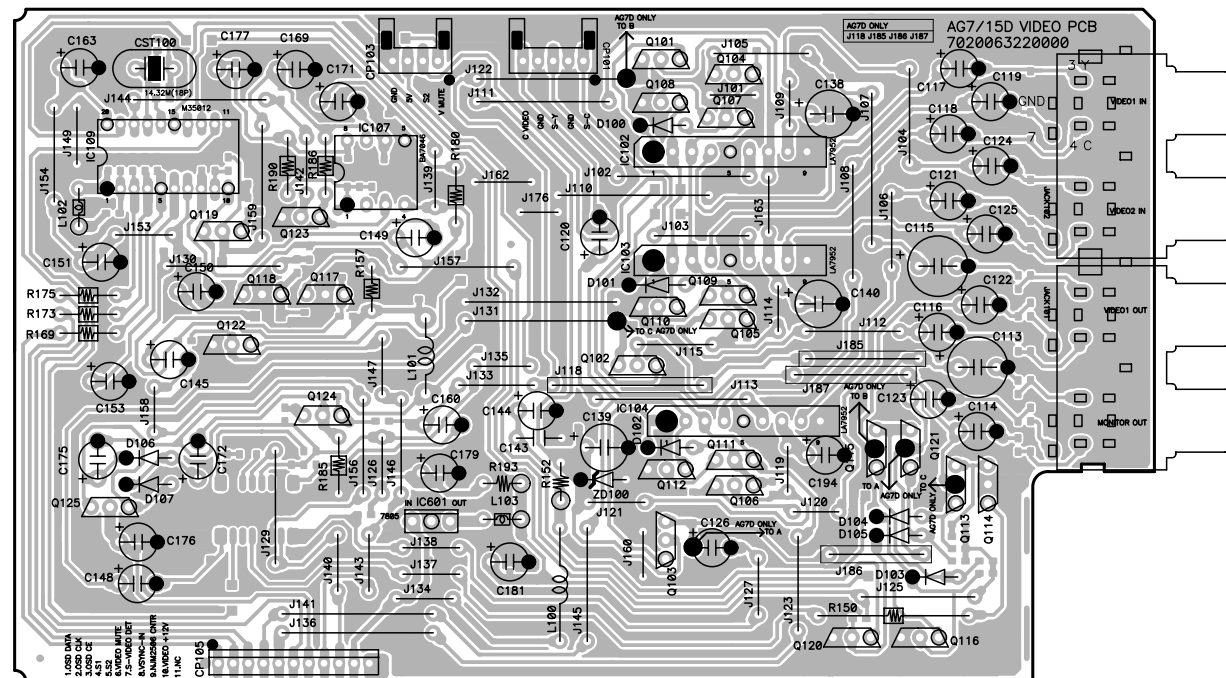

VIDEO PCB (SIDE B)

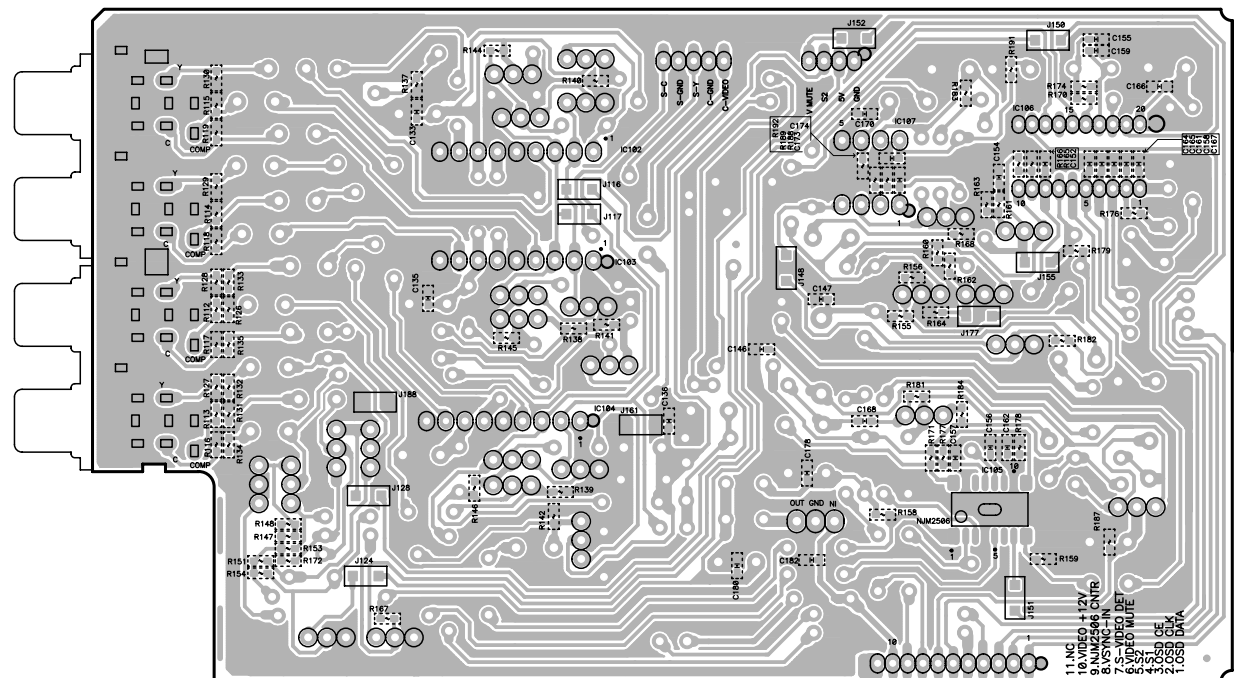

COMPONENT PCB (SIDE A)

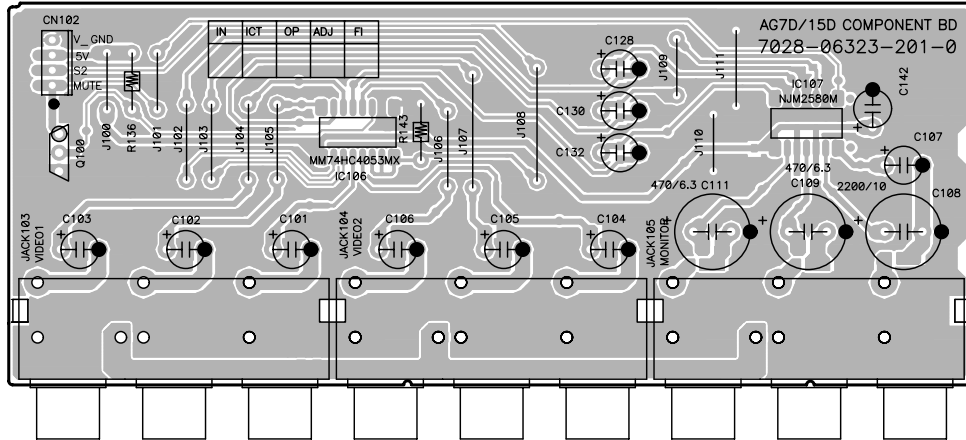

COMPONENT PCB (SIDE B)

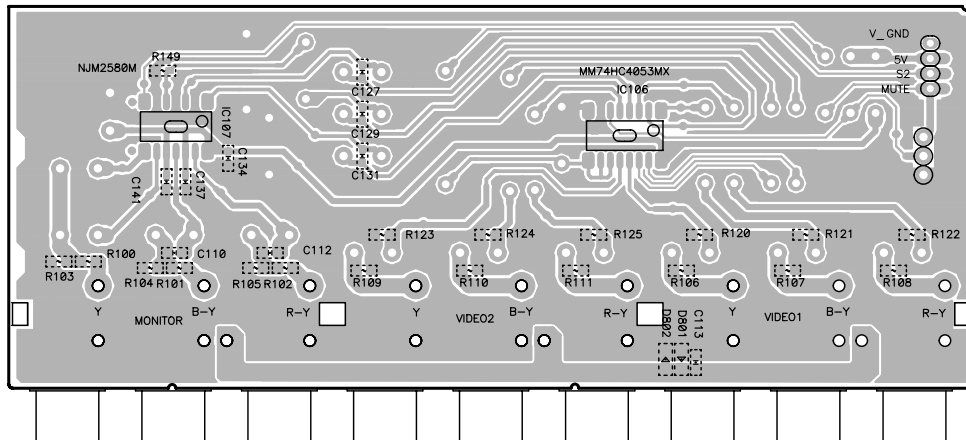

ST-BY PCB

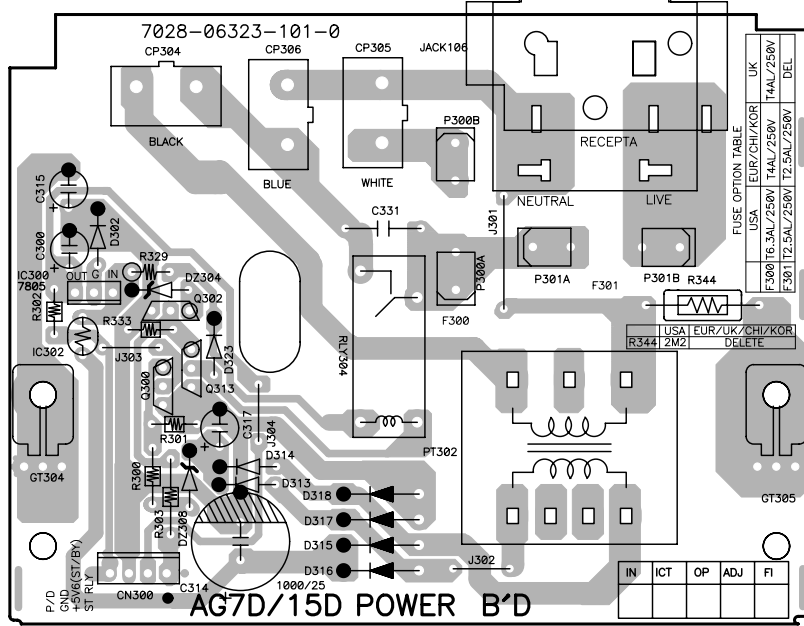

HP PCB

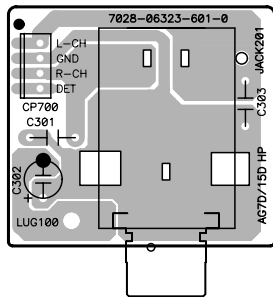

POWER SW PCB

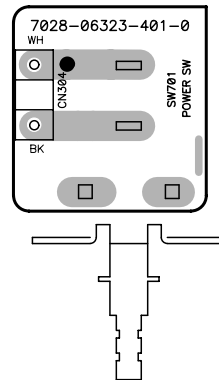

ST-BY SW PCB

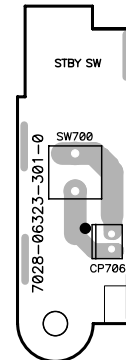

MAIN PCB ASSY [E]

REF. NO.	PARTS NO.	DESCRIPTION
	7028063251070	MAIN PCB ASSY [E]
	7020063250001	MAIN PCB
	2120210748020	HEAT SINK
C326	△ D040682083000	C, ELECT 6800UF M 16V
C329	△ D040472084210	C, ELECT 4700UF M 25V
C330	△ D040102084060	C, ELECT 1000UF M 25V
C340	△ D040682088010	C, ELECT 6800UF M 63V
C341	△ D040682088010	C, ELECT 6800UF M 63V
C348	△ D02010406C060	C, POLY 0.1UF J 100V
C350	△ D02010406C060	C, POLY 0.1UF J 100V
C351	△ D02010406C060	C, POLY 0.1UF J 100V
C352	△ D02010406C060	C, POLY 0.1UF J 100V
C353	△ D02010406C060	C, POLY 0.1UF J 100V
CN501	L101100041710	CN WAFER, TUC-P17P-B1
CN506	L101100041810	CN WAFER, TUC-P18P-B1
CN512	L101100041110	CN WAFER, TUC-P11P-B1
CP300	L104353280300	CN WAFER, 35328-0310
CP301	L102526700800	CN WAFER, 5267-08A
CP302	L104353130600	CN WAFER, 35313-0610
CP307	L102526700600	CN WAFER, 5267-06A
CP507	L131111700010	CN FPC, SCB 1117-00 17P
CP509	L131111500010	CN FPC, SCB 1115-00 15P
CP513	L102526700400	CN WAFER, 5267-04A
CP514	L101220070000	CN WAFER, G1L-S-7P-S2T2-EF
CP516	L101220040000	CN WAFER, G1L-S-4P-S2T2-EF
D303	K000013300520	D, 1SS133T-72
D305	K000400700520	D, IN4007
D306	K000013300520	D, 1SS133T-72
D307	K000013300520	D, 1SS133T-72
D309	K005041480020	D, CHIP 1N4148W
D310	K005041480020	D, CHIP 1N4148W
D311	K005041480020	D, CHIP 1N4148W
D319	K000013300520	D, 1SS133T-72
D320	K000013300520	D, 1SS133T-72
D321	K000013300520	D, 1SS133T-72
D322	K000013300520	D, 1SS133T-72
D325	K06005R144520	D, ZENER MTZJ5. 1B
D327	K000013300520	D, 1SS133T-72
D328	△ K000400700520	D, IN4007
D329	△ K000400700520	D, IN4007
D330	△ K000400700520	D, IN4007
D331	△ K000400700520	D, IN4007
D332	△ K000400700520	D, IN4007
D333	△ K000400700520	D, IN4007
D334	△ K047604000020	D, BRIDGE KBPC604
D335	△ K047604000020	D, BRIDGE KBPC604
D501	K005041480020	D, CHIP 1N4148W
D502	K005041480020	D, CHIP 1N4148W
D505	K005041480020	D, CHIP 1N4148W
D506	K005041480020	D, CHIP 1N4148W
D507	K005041480020	D, CHIP 1N4148W
D508	K005041480020	D, CHIP 1N4148W
D509	K005041480020	D, CHIP 1N4148W
D510	K005041480020	D, CHIP 1N4148W
D511	K005041480020	D, CHIP 1N4148W

MAIN PCB ASSY [E]

REF. NO.	PARTS NO.	DESCRIPTION
D512	K005041480020	D, CHIP 1N4148W
D515	K005041480020	D, CHIP 1N4148W
D516	K005041480020	D, CHIP 1N4148W
D517	K000013300520	D, 1SS133T-72
D518	K000013300520	D, 1SS133T-72
D520	K000013300520	D, 1SS133T-72
D521	K000400700520	D, IN4007
DZ300	K06016R044520	D, ZENER MTZJ16B
DZ301	K06016R044520	D, ZENER MTZJ16B
DZ510	K06007R544530	D, ZENER MTZJ7. 5A
DZ511	K06007R544530	D, ZENER MTZJ7. 5A
DZ512	K06003R344520	D, ZENER MTZJ3. 3B
DZ513	K06005R144520	D, ZENER MTZJ5. 1B
GND303	3790040876010	TERMINAL, GND PLATE
GND304	3790040876010	TERMINAL, GND PLATE
IC301	△ J126781200220	IC, CJ7812F
IC303	△ J126780500400	IC, CJ7805F
IC304	△ J126781200220	IC, CJ7812F
IC305	△ J126791200130	IC, CJ7912F
IC501	J020703210105	IC, CPU UPD703210YGC-105-8BT
IC502	J000240860010	IC, EEPROM MC24C08-WMN6
IC503	J124192400010	IC, BU1924F
IC508	J121455800150	IC, CJ4558CP
IC509	J084115700010	IC, NJW1157
JK302	G612405E1200Y	TERMINAL, BOARD SCREW 4P
JK303	G614801A1400Y	TERMINAL, BOARD SCREW 8P
JK304	G601207E0200Y	TERMINAL, RCA 2PIN
JK305	G602405B0400Y	TERMINAL, RCA 4PIN
JK306	G607902AA101Y	TERMINAL, RCA 9PIN
JK307	G602405B0400Y	TERMINAL, RCA 4PIN
JK308	G602405B0400Y	TERMINAL, RCA 4PIN
Q301	△ J5000916Y0050	TR, KSA916Y
Q303	J5001266Y0050	TR, KTA1266Y
Q304	J5023198Y0000	TR, KTC3198Y
Q307	J5020107S0050	TR, CHIP KRC107S
Q308	J5020107S0050	TR, CHIP KRC107S
Q309	J5020107S0050	TR, CHIP KRC107S
Q311	J5023198Y0000	TR, KTC3198Y
Q312	J5023198Y0000	TR, KTC3198Y
Q314	J5023198Y0000	TR, KTC3198Y
Q315	J5023198Y0000	TR, KTC3198Y
Q316	J5001268B0050	TR, KTA1268BL
Q317	J5023198Y0000	TR, KTC3198Y
Q318	J5001268B0050	TR, KTA1268BL
Q319	J5001268B0050	TR, KTA1268BL
Q320	J5023198Y0000	TR, KTC3198Y
Q321	J5023198Y0000	TR, KTC3198Y
Q322	J5001268B0050	TR, KTA1268BL
Q323	J5001268B0050	TR, KTA1268BL
Q324	J5001268B0050	TR, KTA1268BL
Q507	J5200107S0050	TR, CHIP KRA107S(PH)
Q508	J5200107S0050	TR, CHIP KRA107S(PH)
Q509	J5200107S0050	TR, CHIP KRA107S(PH)
Q510	J5200107S0050	TR, CHIP KRA107S(PH)
Q511	J5200107S0050	TR, CHIP KRA107S(PH)

MAIN PCB ASSY [E]

REF. NO.	PARTS NO.	DESCRIPTION
Q512	J5222875B0010	TR, CHIP KTC2875B (MB)
Q513	J5222875B0010	TR, CHIP KTC2875B (MB)
Q514	J5222875B0010	TR, CHIP KTC2875B (MB)
Q515	J5222875B0010	TR, CHIP KTC2875B (MB)
Q516	J5222875B0010	TR, CHIP KTC2875B (MB)
Q517	J5222875B0010	TR, CHIP KTC2875B (MB)
Q518	J5222875B0010	TR, CHIP KTC2875B (MB)
Q521	J5222875B0010	TR, CHIP KTC2875B (MB)
Q522	J5200107S0050	TR, CHIP KRA107S (PH)
Q525	J5222875B0010	TR, CHIP KTC2875B (MB)
Q543	J5222875B0010	TR, CHIP KTC2875B (MB)
Q544	J522010200210	TR, CHIP KRC102S (NB)
R304	△ C0604R7065050	R, METAL 4.7 J 1W
R315	△ C060010065050	R, METAL 10 J 1W
R317	△ C060010065050	R, METAL 10 J 1W
R318	△ C060010065050	R, METAL 10 J 1W
R319	△ C060010065050	R, METAL 10 J 1W
R320	△ C060010065050	R, METAL 10 J 1W
R321	△ C060010065050	R, METAL 10 J 1W
R336	△ C060022265050	R, METAL 2.2K J 1W
R338	△ C060022265050	R, METAL 2.2K J 1W
R342	△ C060022265050	R, METAL 2.2K J 1W
R351	△ C141R10069000	R, CEMENT 0.1 J 5W
R352	△ C141R10069000	R, CEMENT 0.1 J 5W
R354	△ C060R22065050	R, METAL 0.22 J 1W
R355	△ C060R22065050	R, METAL 0.22 J 1W
R356	△ C060R22065050	R, METAL 0.22 J 1W
R359	△ C060R22065050	R, METAL 0.22 J 1W
R516	△ C1012R2064060	R, FUSIBLE METAL 2.2 J 1/2W
R517	△ C1012R2064060	R, FUSIBLE METAL 2.2 J 1/2W
R518	△ C060010165060	R, METAL 100 J 1W
R519	△ C060010165060	R, METAL 100 J 1W
RLY300	G680120502040	RELAY, G5PA-28-NW DC12V
RLY301	G680120502040	RELAY, G5PA-28-NW DC12V
RLY302	G680120502040	RELAY, G5PA-28-NW DC12V
XTAL501	E830100000060	RESONATOR, CERAMIC
XTAL502	E800433200090	CRYSTAL, 4.332MHZ

MAIN PCB ASSY [A,CN]

REF. NO.	PARTS NO.	DESCRIPTION
	70280632510D0	MAIN PCB ASSY [A,CN]
	7020063250001	MAIN PCB
	2120210748020	HEAT SINK
C326	△ D040682083000	C, ELECT 6800UF M 16V
C329	△ D040472084210	C, ELECT 4700UF M 25V
C330	△ D040102084060	C, ELECT 1000UF M 25V
C340	△ D040682088010	C, ELECT 6800UF M 63V
C341	△ D040682088010	C, ELECT 6800UF M 63V
C348	△ D02010406C060	C, POLY 0.1UF J 100V
C350	△ D02010406C060	C, POLY 0.1UF J 100V
C351	△ D02010406C060	C, POLY 0.1UF J 100V
C352	△ D02010406C060	C, POLY 0.1UF J 100V

MAIN PCB ASSY [A,CN]

REF. NO.	PARTS NO.	DESCRIPTION
C353	△ D02010406C060	C, POLY 0.1UF J 100V
CN501	L101100041710	CN WAFER, TUC-P17P-B1
CN506	L101100041810	CN WAFER, TUC-P18P-B1
CN512	L101100041110	CN WAFER, TUC-P11P-B1
CP300	L104353280300	CN WAFER, 35328-0310
CP301	L102526700800	CN WAFER, 5267-08A
CP302	L104353130600	CN WAFER, 35313-0610
CP307	L102526700600	CN WAFER, 5267-06A
CP507	L131111700010	CN FPC, SCB 1117-00 17P
CP509	L131111500010	CN FPC, SCB 1115-00 15P
CP513	L102526700400	CN WAFER, 5267-04A
CP514	L101220070000	CN WAFER, G1L-S-7P-S2T2-EF
CP516	L101220040000	CN WAFER, G1L-S-4P-S2T2-EF
D303	K000013300520	D, 1SS133T-72
D305	K000400700520	D, IN4007
D306	K000013300520	D, 1SS133T-72
D307	K000013300520	D, 1SS133T-72
D309	K005041480020	D, CHIP 1N4148W
D310	K005041480020	D, CHIP 1N4148W
D311	K005041480020	D, CHIP 1N4148W
D319	K000013300520	D, 1SS133T-72
D320	K000013300520	D, 1SS133T-72
D321	K000013300520	D, 1SS133T-72
D322	K000013300520	D, 1SS133T-72
D325	K06005R144520	D, ZENER MTZJ5.1B
D327	K000013300520	D, 1SS133T-72
D328	△ K000400700520	D, IN4007
D329	△ K000400700520	D, IN4007
D330	△ K000400700520	D, IN4007
D331	△ K000400700520	D, IN4007
D332	△ K000400700520	D, IN4007
D333	△ K000400700520	D, IN4007
D334	△ K047604000020	D, BRIDGE KBPC604
D335	△ K047604000020	D, BRIDGE KBPC604
D501	K005041480020	D, CHIP 1N4148W
D502	K005041480020	D, CHIP 1N4148W
D505	K005041480020	D, CHIP 1N4148W
D506	K005041480020	D, CHIP 1N4148W
D507	K005041480020	D, CHIP 1N4148W
D508	K005041480020	D, CHIP 1N4148W
D509	K005041480020	D, CHIP 1N4148W
D510	K005041480020	D, CHIP 1N4148W
D511	K005041480020	D, CHIP 1N4148W
D512	K005041480020	D, CHIP 1N4148W
D515	K005041480020	D, CHIP 1N4148W
D516	K005041480020	D, CHIP 1N4148W
D517	K000013300520	D, 1SS133T-72
D518	K000013300520	D, 1SS133T-72
D520	K000013300520	D, 1SS133T-72
D521	K000400700520	D, IN4007
DZ300	K06016R044520	D, ZENER MTZJ16B
DZ301	K06016R044520	D, ZENER MTZJ16B
DZ510	K06007R544530	D, ZENER MTZJ7.5A
DZ511	K06007R544530	D, ZENER MTZJ7.5A
DZ512	K06003R344520	D, ZENER MTZJ3.3B

MAIN PCB ASSY [A,CN]

REF. NO.	PARTS NO.	DESCRIPTION
GND303	3790040876010	TERMINAL, GND PLATE
GND304	3790040876010	TERMINAL, GND PLATE
IC301	△ J126781200220	IC, CJ7812F
IC303	△ J126780500400	IC, CJ7805F
IC304	△ J126781200220	IC, CJ7812F
IC305	△ J126791200130	IC, CJ7912F
IC501	J020703210105	IC, CPU UPD703210YGC-105-8BT
IC502	J000240860010	IC, EEPROM MC24C08-WMN6
IC508	J121455800150	IC, CJ4558CP
IC509	J084115700010	IC, NJW1157
JK302	G612405E1200Y	TERMINAL, BOARD SCREW 4P
JK303	G614801A1400Y	TERMINAL, BOARD SCREW 8P
JK304	G601207E0200Y	TERMINAL, RCA 2PIN
JK305	G602405B0400Y	TERMINAL, RCA 4PIN
JK306	G607902AA101Y	TERMINAL, RCA 9PIN
JK307	G602405B0400Y	TERMINAL, RCA 4PIN
JK308	G602405B0400Y	TERMINAL, RCA 4PIN
Q301	△ J5000916Y0050	TR, KSA916Y
Q303	J5001266Y0050	TR, KTA1266Y
Q304	J5023198Y0000	TR, KTC3198Y
Q307	J5020107S0050	TR, CHIP KRC107S
Q308	J5020107S0050	TR, CHIP KRC107S
Q309	J5020107S0050	TR, CHIP KRC107S
Q311	J5023198Y0000	TR, KTC3198Y
Q312	J5023198Y0000	TR, KTC3198Y
Q314	J5023198Y0000	TR, KTC3198Y
Q315	J5023198Y0000	TR, KTC3198Y
Q316	J5001268B0050	TR, KTA1268BL
Q317	J5023198Y0000	TR, KTC3198Y
Q318	J5001268B0050	TR, KTA1268BL
Q319	J5001268B0050	TR, KTA1268BL
Q320	J5023198Y0000	TR, KTC3198Y
Q321	J5023198Y0000	TR, KTC3198Y
Q322	J5001268B0050	TR, KTA1268BL
Q323	J5001268B0050	TR, KTA1268BL
Q324	J5001268B0050	TR, KTA1268BL
Q507	J5200107S0050	TR, CHIP KRA107S (PH)
Q508	J5200107S0050	TR, CHIP KRA107S (PH)
Q509	J5200107S0050	TR, CHIP KRA107S (PH)
Q510	J5200107S0050	TR, CHIP KRA107S (PH)
Q511	J5200107S0050	TR, CHIP KRA107S (PH)
Q512	J5222875B0010	TR, CHIP KTC2875B (MB)
Q513	J5222875B0010	TR, CHIP KTC2875B (MB)
Q514	J5222875B0010	TR, CHIP KTC2875B (MB)
Q515	J5222875B0010	TR, CHIP KTC2875B (MB)
Q516	J5222875B0010	TR, CHIP KTC2875B (MB)
Q517	J5222875B0010	TR, CHIP KTC2875B (MB)
Q518	J5222875B0010	TR, CHIP KTC2875B (MB)
Q521	J5222875B0010	TR, CHIP KTC2875B (MB)
Q522	J5200107S0050	TR, CHIP KRA107S (PH)
Q525	J5222875B0010	TR, CHIP KTC2875B (MB)
Q543	J5222875B0010	TR, CHIP KTC2875B (MB)
Q544	J522010200210	TR, CHIP KRC102S (NB)
R304	△ C0604R7065050	R, METAL 4.7 J 1W
R315	△ C060010065050	R, METAL 10 J 1W

MAIN PCB ASSY [A,CN]

REF. NO.	PARTS NO.	DESCRIPTION
R317	△ C060010065050	R, METAL 10 J 1W
R318	△ C060010065050	R, METAL 10 J 1W
R319	△ C060010065050	R, METAL 10 J 1W
R320	△ C060010065050	R, METAL 10 J 1W
R321	△ C060010065050	R, METAL 10 J 1W
R336	△ C060022265050	R, METAL 2.2K J 1W
R338	△ C060022265050	R, METAL 2.2K J 1W
R342	△ C060022265050	R, METAL 2.2K J 1W
R351	△ C141R10069000	R, CEMENT 0.1 J 5W
R352	△ C141R10069000	R, CEMENT 0.1 J 5W
R354	△ C060R22065050	R, METAL 0.22 J 1W
R355	△ C060R22065050	R, METAL 0.22 J 1W
R356	△ C060R22065050	R, METAL 0.22 J 1W
R359	△ C060R22065050	R, METAL 0.22 J 1W
R516	△ C1012R2064060	R, FUSIBLE METAL 2.2 J 1/2W
R517	△ C1012R2064060	R, FUSIBLE METAL 2.2 J 1/2W
R518	△ C060010165060	R, METAL 100 J 1W
R519	△ C060010165060	R, METAL 100 J 1W
RLY300	G680120502040	RELAY, G5PA-28-NW DC12V
RLY301	G680120502040	RELAY, G5PA-28-NW DC12V
RLY302	G680120502040	RELAY, G5PA-28-NW DC12V
XTAL501	E830100000060	RESONATOR, CERAMIC

MAIN PCB ASSY [K]

REF. NO.	PARTS NO.	DESCRIPTION
	7028063251080	MAIN PCB ASSY [K]
	7020063250001	MAIN PCB
	2120210748020	HEAT SINK
C326	△ D040682083000	C, ELECT 6800UF M 16V
C329	△ D040472084210	C, ELECT 4700UF M 25V
C330	△ D040102084060	C, ELECT 1000UF M 25V
C340	△ D040682088010	C, ELECT 6800UF M 63V
C341	△ D040682088010	C, ELECT 6800UF M 63V
C348	△ D02010406C060	C, POLY 0.1UF J 100V
C350	△ D02010406C060	C, POLY 0.1UF J 100V
C351	△ D02010406C060	C, POLY 0.1UF J 100V
C352	△ D02010406C060	C, POLY 0.1UF J 100V
C353	△ D02010406C060	C, POLY 0.1UF J 100V
CN501	L101100041710	CN WAFER, TUC-P17P-B1
CN506	L101100041810	CN WAFER, TUC-P18P-B1
CN512	L101100041110	CN WAFER, TUC-P11P-B1
CP300	L104353280300	CN WAFER, 35328-0310
CP301	L102526700800	CN WAFER, 5267-08A
CP302	L104353130600	CN WAFER, 35313-0610
CP307	L102526700600	CN WAFER, 5267-06A
CP507	L131111700010	CN FPC, SCB 1117-00 17P
CP509	L131111500010	CN FPC, SCB 1115-00 15P
CP513	L102526700400	CN WAFER, 5267-04A
CP514	L101220070000	CN WAFER, G1L-S-7P-S2T2-EF
CP516	L101220040000	CN WAFER, G1L-S-4P-S2T2-EF
D303	K000013300520	D, 1SS133T-72
D305	K000400700520	D, IN4007

MAIN PCB ASSY [K]

REF. NO.	PARTS NO.	DESCRIPTION
D306	K000013300520	D, 1SS133T-72
D307	K000013300520	D, 1SS133T-72
D309	K005041480020	D, CHIP 1N4148W
D310	K005041480020	D, CHIP 1N4148W
D311	K005041480020	D, CHIP 1N4148W
D319	K000013300520	D, 1SS133T-72
D320	K000013300520	D, 1SS133T-72
D321	K000013300520	D, 1SS133T-72
D322	K000013300520	D, 1SS133T-72
D325	K06005R144520	D, ZENER MTZJ5. 1B
D327	K000013300520	D, 1SS133T-72
D328	△ K000400700520	D, IN4007
D329	△ K000400700520	D, IN4007
D330	△ K000400700520	D, IN4007
D331	△ K000400700520	D, IN4007
D332	△ K000400700520	D, IN4007
D333	△ K000400700520	D, IN4007
D334	△ K047604000020	D, BRIDGE KBPC604
D335	△ K047604000020	D, BRIDGE KBPC604
D501	K005041480020	D, CHIP 1N4148W
D502	K005041480020	D, CHIP 1N4148W
D505	K005041480020	D, CHIP 1N4148W
D506	K005041480020	D, CHIP 1N4148W
D507	K005041480020	D, CHIP 1N4148W
D508	K005041480020	D, CHIP 1N4148W
D509	K005041480020	D, CHIP 1N4148W
D510	K005041480020	D, CHIP 1N4148W
D511	K005041480020	D, CHIP 1N4148W
D512	K005041480020	D, CHIP 1N4148W
D515	K005041480020	D, CHIP 1N4148W
D516	K005041480020	D, CHIP 1N4148W
D517	K000013300520	D, 1SS133T-72
D518	K000013300520	D, 1SS133T-72
D520	K000013300520	D, 1SS133T-72
D521	K000400700520	D, IN4007
DZ300	K06016R044520	D, ZENER MTZJ16B
DZ301	K06016R044520	D, ZENER MTZJ16B
DZ510	K06007R544530	D, ZENER MTZJ7. 5A
DZ511	K06007R544530	D, ZENER MTZJ7. 5A
DZ512	K06003R344520	D, ZENER MTZJ3. 3B
GND303	3790040876010	TERMINAL, GND PLATE
GND304	3790040876010	TERMINAL, GND PLATE
IC301	△ J126781200220	IC, CJ7812F
IC303	△ J126780500400	IC, CJ7805F
IC304	△ J126781200220	IC, CJ7812F
IC305	△ J126791200130	IC, CJ7912F
IC501	J020703210105	IC, CPU UPD703210YGC-105-8BT
IC502	J000240860010	IC, EEPROM MC24C08-WMN6
IC508	J121455800150	IC, CJ4558CP
IC509	J084115700010	IC, NJW1157
JK302	G612405E1200Y	TERMINAL, BOARD SCREW 4P
JK303	G614801A1400Y	TERMINAL, BOARD SCREW 8P
JK304	G601207E0200Y	TERMINAL, RCA 2PIN
JK305	G602405B0400Y	TERMINAL, RCA 4PIN
JK306	G607902AA101Y	TERMINAL, RCA 9PIN

MAIN PCB ASSY [K]

REF. NO.	PARTS NO.	DESCRIPTION
JK307	G602405B0400Y	TERMINAL, RCA 4PIN
JK308	G602405B0400Y	TERMINAL, RCA 4PIN
Q301	△ J5000916Y0050	TR, KSA916Y
Q303	J5001266Y0050	TR, KTA1266Y
Q304	J5023198Y0000	TR, KTC3198Y
Q307	J5020107S0050	TR, CHIP KRC107S
Q308	J5020107S0050	TR, CHIP KRC107S
Q309	J5020107S0050	TR, CHIP KRC107S
Q311	J5023198Y0000	TR, KTC3198Y
Q312	J5023198Y0000	TR, KTC3198Y
Q314	J5023198Y0000	TR, KTC3198Y
Q315	J5023198Y0000	TR, KTC3198Y
Q316	J5001268B0050	TR, KTA1268BL
Q317	J5023198Y0000	TR, KTC3198Y
Q318	J5001268B0050	TR, KTA1268BL
Q319	J5001268B0050	TR, KTA1268BL
Q320	J5023198Y0000	TR, KTC3198Y
Q321	J5023198Y0000	TR, KTC3198Y
Q322	J5001268B0050	TR, KTA1268BL
Q323	J5001268B0050	TR, KTA1268BL
Q324	J5001268B0050	TR, KTA1268BL
Q507	J5200107S0050	TR, CHIP KRA107S (PH)
Q508	J5200107S0050	TR, CHIP KRA107S (PH)
Q509	J5200107S0050	TR, CHIP KRA107S (PH)
Q510	J5200107S0050	TR, CHIP KRA107S (PH)
Q511	J5200107S0050	TR, CHIP KRA107S (PH)
Q512	J5222875B0010	TR, CHIP KTC2875B (MB)
Q513	J5222875B0010	TR, CHIP KTC2875B (MB)
Q514	J5222875B0010	TR, CHIP KTC2875B (MB)
Q515	J5222875B0010	TR, CHIP KTC2875B (MB)
Q516	J5222875B0010	TR, CHIP KTC2875B (MB)
Q517	J5222875B0010	TR, CHIP KTC2875B (MB)
Q518	J5222875B0010	TR, CHIP KTC2875B (MB)
Q521	J5222875B0010	TR, CHIP KTC2875B (MB)
Q522	J5200107S0050	TR, CHIP KRA107S (PH)
Q525	J5222875B0010	TR, CHIP KTC2875B (MB)
Q543	J5222875B0010	TR, CHIP KTC2875B (MB)
Q544	J522010200210	TR, CHIP KRC102S (NB)
R304	△ C0604R7065050	R, METAL 4.7 J 1W
R315	△ C060010065050	R, METAL 10 J 1W
R317	△ C060010065050	R, METAL 10 J 1W
R318	△ C060010065050	R, METAL 10 J 1W
R319	△ C060010065050	R, METAL 10 J 1W
R320	△ C060010065050	R, METAL 10 J 1W
R321	△ C060010065050	R, METAL 10 J 1W
R336	△ C060022265050	R, METAL 2.2K J 1W
R338	△ C060022265050	R, METAL 2.2K J 1W
R342	△ C060022265050	R, METAL 2.2K J 1W
R351	△ C141R10069000	R, CEMENT 0.1 J 5W
R352	△ C141R10069000	R, CEMENT 0.1 J 5W
R354	△ C060R22065050	R, METAL 0.22 J 1W
R355	△ C060R22065050	R, METAL 0.22 J 1W
R356	△ C060R22065050	R, METAL 0.22 J 1W
R359	△ C060R22065050	R, METAL 0.22 J 1W
R516	△ C1012R2064060	R, FUSIBLE METAL 2.2 J 1/2W

MAIN PCB ASSY [K]

REF. NO.	PARTS NO.	DESCRIPTION
R517	△ C1012R2064060	R, FUSIBLE METAL 2.2 J 1/2W
R518	△ C060010165060	R, METAL 100 J 1W
R519	△ C060010165060	R, METAL 100 J 1W
RLY300	G680120502040	RELAY, G5PA-28-NW DC12V
RLY301	G680120502040	RELAY, G5PA-28-NW DC12V
RLY302	G680120502040	RELAY, G5PA-28-NW DC12V
XTAL501	E830100000060	RESONATOR, CERAMIC

AMP PCB ASSY

REF. NO.	PARTS NO.	DESCRIPTION
	7028063261010	AMP PCB ASSY
	7020063260000	AMP PCB
CP204	L101220040000	CN WAFER, G1L-S-4P-S2T2-EF
CP205	L101220150000	CN WAFER, G1L-S-15P-S2T2-EF
D201C	K000013300520	D, 1SS133T-72
D201FL	K000013300520	D, 1SS133T-72
D201FR	K000013300520	D, 1SS133T-72
D201SB	K000013300520	D, 1SS133T-72
D201SL	K000013300520	D, 1SS133T-72
D201SR	K000013300520	D, 1SS133T-72
D203	K000013300520	D, 1SS133T-72
L201C	D330900001320	COIL, FILTER-INDUCTOR J9000031
L201FL	D330900001320	COIL, FILTER-INDUCTOR J9000031
L201FR	D330900001320	COIL, FILTER-INDUCTOR J9000031
L201SB	D330900001320	COIL, FILTER-INDUCTOR J9000031
L201SL	D330900001320	COIL, FILTER-INDUCTOR J9000031
L201SR	D330900001320	COIL, FILTER-INDUCTOR J9000031
Q201C	J5000992F0050	TR, KSA992F
Q201FL	J5000992F0050	TR, KSA992F
Q201FR	J5000992F0050	TR, KSA992F
Q201SB	J5000992F0050	TR, KSA992F
Q201SL	J5000992F0050	TR, KSA992F
Q201SR	J5000992F0050	TR, KSA992F
Q202C	J5000992F0050	TR, KSA992F
Q202FL	J5000992F0050	TR, KSA992F
Q202FR	J5000992F0050	TR, KSA992F
Q202SB	J5000992F0050	TR, KSA992F
Q202SL	J5000992F0050	TR, KSA992F
Q202SR	J5000992F0050	TR, KSA992F
Q203C	J5021845F0000	TR, KSC1845F
Q203FL	J5021845F0000	TR, KSC1845F
Q203FR	J5021845F0000	TR, KSC1845F
Q203SB	J5021845F0000	TR, KSC1845F
Q203SL	J5021845F0000	TR, KSC1845F
Q203SR	J5021845F0000	TR, KSC1845F
Q207C	J5021845F0000	TR, KSC1845F
Q207FL	J5021845F0000	TR, KSC1845F
Q207FR	J5021845F0000	TR, KSC1845F
Q207SB	J5021845F0000	TR, KSC1845F
Q207SL	J5021845F0000	TR, KSC1845F
Q207SR	J5021845F0000	TR, KSC1845F
Q208	J6020107M0010	TR, KRC107M

AMP PCB ASSY

REF. NO.	PARTS NO.	DESCRIPTION
R216C	△ C060056265050	R, METAL 5.6K J 1W
R216FL	△ C060056265050	R, METAL 5.6K J 1W
R216FR	△ C060056265050	R, METAL 5.6K J 1W
R216SB	△ C060056265050	R, METAL 5.6K J 1W
R216SL	△ C060056265050	R, METAL 5.6K J 1W
R216SR	△ C060056265050	R, METAL 5.6K J 1W
R217C	△ C060056265050	R, METAL 5.6K J 1W
R217FL	△ C060056265050	R, METAL 5.6K J 1W
R217FR	△ C060056265050	R, METAL 5.6K J 1W
R217SB	△ C060056265050	R, METAL 5.6K J 1W
R217SL	△ C060056265050	R, METAL 5.6K J 1W
R217SR	△ C060056265050	R, METAL 5.6K J 1W
R220C	△ C060R22065050	R, METAL 0.22 J 1W
R220FL	△ C060R22065050	R, METAL 0.22 J 1W
R220FR	△ C060R22065050	R, METAL 0.22 J 1W
R220SB	△ C060R22065050	R, METAL 0.22 J 1W
R220SL	△ C060R22065050	R, METAL 0.22 J 1W
R220SR	△ C060R22065050	R, METAL 0.22 J 1W
R221C	△ C060R22065050	R, METAL 0.22 J 1W
R221FL	△ C060R22065050	R, METAL 0.22 J 1W
R221FR	△ C060R22065050	R, METAL 0.22 J 1W
R221SB	△ C060R22065050	R, METAL 0.22 J 1W
R221SL	△ C060R22065050	R, METAL 0.22 J 1W
R221SR	△ C060R22065050	R, METAL 0.22 J 1W
R222C	△ C060R22065050	R, METAL 0.22 J 1W
R222FL	△ C060R22065050	R, METAL 0.22 J 1W
R222FR	△ C060R22065050	R, METAL 0.22 J 1W
R222SB	△ C060R22065050	R, METAL 0.22 J 1W
R222SL	△ C060R22065050	R, METAL 0.22 J 1W
R222SR	△ C060R22065050	R, METAL 0.22 J 1W
R223C	△ C060R22065050	R, METAL 0.22 J 1W
R223FL	△ C060R22065050	R, METAL 0.22 J 1W
R223FR	△ C060R22065050	R, METAL 0.22 J 1W
R223SB	△ C060R22065050	R, METAL 0.22 J 1W
R223SL	△ C060R22065050	R, METAL 0.22 J 1W
R223SR	△ C060R22065050	R, METAL 0.22 J 1W
R228C	△ C060010065520	R, METAL 10 1W
R228FL	△ C060010065520	R, METAL 10 1W
R228FR	△ C060010065520	R, METAL 10 1W
R228SB	△ C060010065520	R, METAL 10 1W
R228SL	△ C060010065520	R, METAL 10 1W
R228SR	△ C060010065520	R, METAL 10 1W
R229	△ C060010065050	R, METAL 10 J 1W
R230	△ C060047166060	R, METAL 470 J 2W
R231	△ C060047166060	R, METAL 470 J 2W
RLY201	G680120202020	RELAY, RSB12 DC12V

FRONT PCB ASSY [E]

REF. NO.	PARTS NO.	DESCRIPTION
	7028063211040	FRONT PCB ASSY [E]
	7020063210000	FRONT PCB
CP704	L102526803010	CN WAFER, 5268-03A
CP705	L131524921720	CN FPC, 52492-1720 17P

FRONT PCB ASSY [E]

REF. NO.	PARTS NO.	DESCRIPTION
D702	K000013300520	D, 1SS133T-72
D703	K000013300520	D, 1SS133T-72
D704	K000013300520	D, 1SS133T-72
DZ707	K06012R044520	D, ZENER MTZJ12B
FLT701	K530125000010	DISPLAY, FLT HNA-12MM50
HOLDER	4320210091010	HOLDER, FLT
IC700	J127631500010	IC, PT6315
JK700	G402041810090	JACK, S-VIDEO
JK701	G606040320020	TERMINAL, RCA 3PIN
L700	D330101001020	COIL, FILTER-INDUCTOR 100UH
L701	D330100700520	COIL, FILTER-INDUCTOR 10UH
LED700	K500056000050	LED, ML50B13H-BEC-T/P (BLUE)
LED701	K500033000020	LED, HL-30CNYUF2T (YELLOW)
LED702	K500056000050	LED, ML50B13H-BEC-T/P (BLUE)
LED703	K500033000020	LED, HL-30CNYUF2T (YELLOW)
Q700	J6020107M0010	TR, KRC107M
Q701	J601107M00050	TR, KRA107M
Q702	J6020107M0010	TR, KRC107M
Q703	J6020107M0010	TR, KRC107M
Q705	J6020107M0010	TR, KRC107M
Q706	J601107M00050	TR, KRA107M
Q707	J6020107M0010	TR, KRC107M
RMC700	E940643800000	MODULE, REMOCON NJL64H380A
SW700	G180000270010	SW, TACT SKHV10920A
SW701	G180000270010	SW, TACT SKHV10920A
SW702	G180000270010	SW, TACT SKHV10920A
SW704	G180000270010	SW, TACT SKHV10920A
SW706	G180000270010	SW, TACT SKHV10920A
SW708	G180000270010	SW, TACT SKHV10920A
SW710-SW729	G180000270010	SW, TACT SKHV10920A
VR700	G121162430400	SW, ENCODER EC16B24304

FRONT PCB ASSY [A,K]

REF. NO.	PARTS NO.	DESCRIPTION
	7028063211020	FRONT PCB ASSY [A, K]
	7020063210000	FRONT PCB
CP704	L102526803010	CN WAFER, 5268-03A
CP705	L131524921720	CN FPC, 52492-1720 17P
D702	K000013300520	D, 1SS133T-72
D703	K000013300520	D, 1SS133T-72
D704	K000013300520	D, 1SS133T-72
DZ707	K06012R044520	D, ZENER MTZJ12B
FLT701	K530125000010	DISPLAY, FLT HNA-12MM50
HOLDER	4320210091010	HOLDER, FLT
IC700	J127631500010	IC, PT6315
JK700	G402041810090	JACK, S-VIDEO
JK701	G606040320020	TERMINAL, RCA 3PIN
L700	D330101001020	COIL, FILTER-INDUCTOR 100UH
L701	D330100700520	COIL, FILTER-INDUCTOR 10UH
LED700	K500056000050	LED, ML50B13H-BEC-T/P (BLUE)
LED701	K500033000020	LED, HL-30CNYUF2T (YELLOW)
LED702	K500056000050	LED, ML50B13H-BEC-T/P (BLUE)

FRONT PCB ASSY [A,K]

REF. NO.	PARTS NO.	DESCRIPTION
LED703	K500033000020	LED, HL-30CNYUF2T (YELLOW)
Q700	J6020107M0010	TR, KRC107M
Q701	J601107M00050	TR, KRA107M
Q702	J6020107M0010	TR, KRC107M
Q703	J6020107M0010	TR, KRC107M
Q705	J6020107M0010	TR, KRC107M
Q706	J601107M00050	TR, KRA107M
Q707	J6020107M0010	TR, KRC107M
RMC700	E940643800000	MODULE, REMOCON NJL64H380A
SW703	G180000270010	SW, TACT SKHV10920A
SW705	G180000270010	SW, TACT SKHV10920A
SW707	G180000270010	SW, TACT SKHV10920A
SW709	G180000270010	SW, TACT SKHV10920A
SW713-SW729	G180000270010	SW, TACT SKHV10920A
VR700	G121162430400	SW, ENCODER EC16B24304

FRONT PCB ASSY [CN]

REF. NO.	PARTS NO.	DESCRIPTION
	7028063211060	FRONT PCB ASSY [CN]
	7020063210000	FRONT PCB
CP704	L102526803010	CN WAFER, 5268-03A
CP705	L131524921720	CN FPC, 52492-1720 17P
D702	K000013300520	D, 1SS133T-72
D703	K000013300520	D, 1SS133T-72
D704	K000013300520	D, 1SS133T-72
DZ707	K06012R044520	D, ZENER MTZJ12B
FLT701	K530125000010	DISPLAY, FLT HNA-12MM50
HOLDER	4320210091010	HOLDER, FLT
IC700	J127631500010	IC, PT6315
JK700	G402041810090	JACK, S-VIDEO
JK701	G606040320000	TERMINAL, RCA 3PIN
L700	D330101001020	COIL, FILTER-INDUCTOR 100UH
L701	D330100700520	COIL, FILTER-INDUCTOR 10UH
LED700	K500056000050	LED, ML50B13H-BEC-T/P (BLUE)
LED701	K500033000020	LED, HL-30CNYUF2T (YELLOW)
LED702	K500056000050	LED, ML50B13H-BEC-T/P (BLUE)
LED703	K500033000020	LED, HL-30CNYUF2T (YELLOW)
Q700	J6020107M0010	TR, KRC107M
Q701	J601107M00050	TR, KRA107M
Q702	J6020107M0010	TR, KRC107M
Q703	J6020107M0010	TR, KRC107M
Q705	J6020107M0010	TR, KRC107M
Q706	J601107M00050	TR, KRA107M
Q707	J6020107M0010	TR, KRC107M
RMC700	E940643800000	MODULE, REMOCON NJL64H380A
SW703	G180000270010	SW, TACT SKHV10920A
SW705	G180000270010	SW, TACT SKHV10920A
SW707	G180000270010	SW, TACT SKHV10920A
SW709	G180000270010	SW, TACT SKHV10920A
SW713-SW729	G180000270010	SW, TACT SKHV10920A
VR700	G121162430400	SW, ENCODER EC16B24304

MULTI PCB ASSY

REF. NO.	PARTS NO.	DESCRIPTION
VR701	7028063212010	MULTI PCB ASSY
	G121161220000	SW, ENCODER EC16B12204

DSP PCB ASSY

REF. NO.	PARTS NO.	DESCRIPTION
	7028063241020	DSP PCB ASSY
	7020063240000	DSP PCB
BD803	7610035500030	COIL, BEAD BFS 3550R2F
BD804	D340160800060	COIL, BEAD MB-160808-0120H
BD805	7610035500030	COIL, BEAD BFS 3550R2F
BD807	D340160800060	COIL, BEAD MB-160808-0120H
BD808	D340160800060	COIL, BEAD MB-160808-0120H
BD809	D340160800060	COIL, BEAD MB-160808-0120H
BD811	D340160800060	COIL, BEAD MB-160808-0120H
BD812	7610035500030	COIL, BEAD BFS 3550R2F
CP800	L101100031810	CN WAFER, TUC-P18X-B1
CP801	L101100031710	CN WAFER, TUC-P17X-B1
D800	K005041480020	D, CHIP 1N4148W
D801	K005041480020	D, CHIP 1N4148W
D802	K005041480020	D, CHIP 1N4148W
D803	K005041480020	D, CHIP 1N4148W
D804	K005041480020	D, CHIP 1N4148W
D805	K005041480020	D, CHIP 1N4148W
D806	K005041480020	D, CHIP 1N4148W
D807	K005041480020	D, CHIP 1N4148W
D808	K005041480020	D, CHIP 1N4148W
D809	K005041480020	D, CHIP 1N4148W
D810	K000400700520	D, 1N4007
IC800	J080458800010	IC, AK4588
IC801	△ J126111725020	IC, RC1117-2.5
IC802	△ J12603R300010	IC, BA033T
IC803	J040742440180	IC, MM74LCX244
IC804	J040742440180	IC, MM74LCX244
IC805	J080494000010	IC, CS49400
IC806	J040742440190	IC, MM74HCT244
IC807	J040742440190	IC, MM74HCT244
IC808	J001421610010	IC, RAM IS42S16100
IC809	J000298070010	IC, EEPROM EN29LV800AT-70TC
IC811	J040740400260	IC, 74VHC04
IC901	J121455800150	IC, CJ4558CP
IC902	J121455800150	IC, CJ4558CP
IC903	J121455800150	IC, CJ4558CP
IC904	J121455800150	IC, CJ4558CP
JACK804	G601020130100	TERMINAL, RCA 2PIN
JK801	E100116500010	MODULE, OPTICAL TRANSMITTER
JK803	E100116500020	MODULE, OPTICAL RECEIVER
L800	D3302R2000150	COIL, FILTER-INDUCTOR 2.2UH
L801	D3304R7000150	COIL, FILTER-INDUCTOR 4.7UH
L803	D3304R7000150	COIL, FILTER-INDUCTOR 4.7UH
L804	D3302R2000150	COIL, FILTER-INDUCTOR 2.2UH
Q801	J522107S00210	TR, CHIP KRC107S(NH)
Q802	J5200107S0050	TR, CHIP KRA107S(PH)

DSP PCB ASSY

REF. NO.	PARTS NO.	DESCRIPTION
Q803	J5200107S0050	TR, CHIP KRA107S(PH)
Q901FL	J5222875B0010	TR, CHIP KTC2875B(MB)
Q901FR	J5222875B0010	TR, CHIP KTC2875B(MB)
Q902SL	J5222875B0010	TR, CHIP KTC2875B(MB)
Q902SR	J5222875B0010	TR, CHIP KTC2875B(MB)
Q903SBL	J5222875B0010	TR, CHIP KTC2875B(MB)
Q903SBR	J5222875B0010	TR, CHIP KTC2875B(MB)
Q904C	J5222875B0010	TR, CHIP KTC2875B(MB)
Q904SW	J5222875B0010	TR, CHIP KTC2875B(MB)
XTAL800	E80012R288080	CRYSTAL, 12.288MHZ

VIDEO PCB ASSY [E,A,CN]

REF. NO.	PARTS NO.	DESCRIPTION
	7028063221040	VIDEO PCB ASSY [E, A, CN]
	7020063220000	VIDEO PCB
CP101	L101220050010	CN WAFER, GIL-S-5P-S2L2-EF
CP103	L101220040010	CN WAFER, GIL-S-04P-S2L2-EF
CP105	L101100031110	CN WAFER, TUC-P11X-B1
D100	K000013300520	D, 1SS133T-72
D101	K000013300520	D, 1SS133T-72
D102	K000013300520	D, 1SS133T-72
IC102	J171795600010	IC, LA7956
IC103	J171795600010	IC, LA7956
IC104	J171795600010	IC, LA7956
IC601	△ J126780500400	IC, CJ7805F
JK101	G601802002010	TERMINAL, RCA 2PIN
JK102	G601802002010	TERMINAL, RCA 2PIN
L100	D330220001020	COIL, FILTER-INDUCTOR 22UH
L103	7610035500030	COIL, BEAD BFS 3550R2F
Q101	J5021740S0010	TR, 2SC1740SR
Q102	J5021740S0010	TR, 2SC1740SR
Q103	J5021740S0010	TR, 2SC1740SR
Q104	J5021740S0010	TR, 2SC1740SR
Q105	J5021740S0010	TR, 2SC1740SR
Q106	J5021740S0010	TR, 2SC1740SR
Q107	J6020107M0010	TR, KRC107M
Q108	J6020107M0010	TR, KRC107M
Q109	J6020107M0010	TR, KRC107M
Q110	J6020107M0010	TR, KRC107M
Q111	J6020107M0010	TR, KRC107M
Q112	J6020107M0010	TR, KRC107M

VIDEO PCB ASSY [K]

REF. NO.	PARTS NO.	DESCRIPTION
	7028063221020	VIDEO PCB ASSY [K]
	7020063220000	VIDEO PCB
CP101	L101220050010	CN WAFER, GIL-S-5P-S2L2-EF
CP103	L101220040010	CN WAFER, GIL-S-04P-S2L2-EF
CP105	L101100031110	CN WAFER, TUC-P11X-B1

VIDEO PCB ASSY [K]

REF. NO.	PARTS NO.	DESCRIPTION
D100	K000013300520	D, 1SS133T-72
D101	K000013300520	D, 1SS133T-72
D102	K000013300520	D, 1SS133T-72
IC102	J171795600010	IC, LA7956
IC103	J171795600010	IC, LA7956
IC104	J171795600010	IC, LA7956
IC601	△ J126780500400	IC, CJ7805F
JK101	G601802002010	TERMINAL, RCA 2PIN
JK102	G601802002010	TERMINAL, RCA 2PIN
L100	D330220001020	COIL, FILTER-INDUCTOR 22UH
L103	7610035500030	COIL, BEAD BFS 3550R2F
Q101	J5021740S0010	TR, 2SC1740SR
Q102	J5021740S0010	TR, 2SC1740SR
Q103	J5021740S0010	TR, 2SC1740SR
Q104	J5021740S0010	TR, 2SC1740SR
Q105	J5021740S0010	TR, 2SC1740SR
Q106	J5021740S0010	TR, 2SC1740SR
Q107	J6020107M0010	TR, KRC107M
Q108	J6020107M0010	TR, KRC107M
Q109	J6020107M0010	TR, KRC107M
Q110	J6020107M0010	TR, KRC107M
Q111	J6020107M0010	TR, KRC107M
Q112	J6020107M0010	TR, KRC107M

COMPONENT PCB ASSY

REF. NO.	PARTS NO.	DESCRIPTION
IC106	7028063232020	COMPONENT PCB ASSY
IC107	J040744053040	IC, MM74HC4053MX
JACK103	J170258000010	IC, NJM2580M
JACK104	G606030164010	TERMINAL, RCA 3PIN
JACK105	G606030164010	TERMINAL, RCA 3PIN
Q100	G606030164010	TERMINAL, RCA 3PIN
Q100	J6020107M0010	TR, KRC107M

ST-BY PCB ASSY [E]

REF. NO.	PARTS NO.	DESCRIPTION
	7028063231050	ST-BY PCB ASSY [E]
	7020063230000	ST-BY PCB
C314	△ D040102084060	C, ELECT 1000UF M 25V
C331	△ D00847208K070	C, CERAMIC AC13F472MDOA
CP304	△ L104353280201	CN WAFER, 35328-0211 (BLACK)
CP305	△ L104353280200	CN WAFER, 35328-0210
CP306	△ L104353280203	CN WAFER, 35328-0213 (BLUE)
D302	K000013300520	D, 1SS133T-72
D313	K000013300520	D, 1SS133T-72
D314	K000013300520	D, 1SS133T-72
D315	△ K000400700520	D, IN4007
D316	△ K000400700520	D, IN4007
D317	△ K000400700520	D, IN4007
D318	△ K000400700520	D, IN4007
D318	△ K000400700520	D, IN4007

ST-BY PCB ASSY [E]

REF. NO.	PARTS NO.	DESCRIPTION
D323	K000013300520	D, 1SS133T-72
DZ304	K06020R044520	D, ZENER MTZJ20B
DZ308	K06005R644520	D, ZENER MTZJ5.6B
F300	△ N751224001110	FUSE, T4A 250V
F301	△ N751222501110	FUSE, T2.5A 250V
GT304	3790040876010	TERMINAL, GND PLATE
GT305	3790040876010	TERMINAL, GND PLATE
IC300	△ J126780500400	IC, CJ7805F
IC302	△ J120001500030	IC, ICP-N15
JACK106	△ G435040110000	SOCKET, POWER RECEPTACLE
P300A	G645000050010	HOLDER, FUSE CLIP
P300B	G645000050010	HOLDER, FUSE CLIP
P301A	G645000050010	HOLDER, FUSE CLIP
P301B	G645000050010	HOLDER, FUSE CLIP
PT302	△ 8200280150130	POWER TRANS, STAND-BY 230V
Q300	J5021740S0010	TR, 2SC1740SR
Q302	J6020107M0010	TR, KRC107M
Q313	J5021740S0010	TR, 2SC1740SR
RLY304	△ G680090102010	RELAY, G5PA-1 DC9V

ST-BY PCB ASSY [A]

REF. NO.	PARTS NO.	DESCRIPTION
	7028063231080	ST-BY PCB ASSY [A]
	7020063230000	ST-BY PCB
C314	△ D040102084060	C, ELECT 1000UF M 25V
C331	△ D00847208K070	C, CERAMIC AC13F472MDOA
CP304	△ L104353280201	CN WAFER, 35328-0211 (BLACK)
CP305	△ L104353280200	CN WAFER, 35328-0210
CP306	△ L104353280203	CN WAFER, 35328-0213 (BLUE)
D302	K000013300520	D, 1SS133T-72
D313	K000013300520	D, 1SS133T-72
D314	K000013300520	D, 1SS133T-72
D315	△ K000400700520	D, IN4007
D316	△ K000400700520	D, IN4007
D317	△ K000400700520	D, IN4007
D318	△ K000400700520	D, IN4007
D323	K000013300520	D, 1SS133T-72
DZ304	K06020R044520	D, ZENER MTZJ20B
DZ308	K06005R644520	D, ZENER MTZJ5.6B
F300	△ N751224001110	FUSE, T4A 250V
GT304	3790040876010	TERMINAL, GND PLATE
GT305	3790040876010	TERMINAL, GND PLATE
IC300	△ J126780500400	IC, CJ7805F
IC302	△ J120001500030	IC, ICP-N15
P300A	G645000050010	HOLDER, FUSE CLIP
P300B	G645000050010	HOLDER, FUSE CLIP
PT302	△ 8200280150130	POWER TRANS, STAND-BY 230V
Q300	J5021740S0010	TR, 2SC1740SR
Q302	J6020107M0010	TR, KRC107M
Q313	J5021740S0010	TR, 2SC1740SR
RLY304	△ G680090102010	RELAY, G5PA-1 DC9V

ST-BY PCB ASSY [CN]

REF. NO.	PARTS NO.	DESCRIPTION
	7028063231070	ST-BY PCB ASSY [CN]
	7020063230000	ST-BY PCB
C314	△ D040102084060	C, ELECT 1000UF M 25V
C331	△ D00847208K070	C, CERAMIC AC13F472MDOA
CP304	△ L104353280201	CN WAFER, 35328-0211 (BLACK)
CP305	△ L104353280200	CN WAFER, 35328-0210
CP306	△ L104353280203	CN WAFER, 35328-0213 (BLUE)
D302	K000013300520	D, 1SS133T-72
D313	K000013300520	D, 1SS133T-72
D314	K000013300520	D, 1SS133T-72
D315	△ K000400700520	D, 1N4007
D316	△ K000400700520	D, 1N4007
D317	△ K000400700520	D, 1N4007
D318	△ K000400700520	D, 1N4007
D323	K000013300520	D, 1SS133T-72
DZ304	K06020R044520	D, ZENER MTZJ20B
DZ308	K06005R644520	D, ZENER MTZJ5. 6B
F300	△ N751224001110	FUSE, T4A 250V
F301	△ N751222501110	FUSE, T2. 5A 250V
GT304	3790040876010	TERMINAL, GND PLATE
GT305	3790040876010	TERMINAL, GND PLATE
IC300	△ J126780500400	IC, CJ7805F
IC302	△ J120001500030	IC, ICP-N15
JACK106	△ G435000130010	SOCKET, POWER RECEPTACLE
P300A	G645000050010	HOLDER, FUSE CLIP
P300B	G645000050010	HOLDER, FUSE CLIP
P301A	G645000050010	HOLDER, FUSE CLIP
P301B	G645000050010	HOLDER, FUSE CLIP
PT302	△ 8200280150210	POWER TRANS, STAND-BY 220V
Q300	J5021740S0010	TR, 2SC1740SR
Q302	J6020107M0010	TR, KRC107M
Q313	J5021740S0010	TR, 2SC1740SR
RLY304	△ G680090102010	RELAY, G5PA-1 DC9V

ST-BY PCB ASSY [K]

REF. NO.	PARTS NO.	DESCRIPTION
	7028063231060	ST-BY PCB ASSY [K]
	7020063230000	ST-BY PCB
C314	△ D040102084060	C, ELECT 1000UF M 25V
C331	△ D00847208K070	C, CERAMIC AC13F472MDOA
CP304	△ L104353280201	CN WAFER, 35328-0211 (BLACK)
CP305	△ L104353280200	CN WAFER, 35328-0210
CP306	△ L104353280203	CN WAFER, 35328-0213 (BLUE)
D302	K000013300520	D, 1SS133T-72
D313	K000013300520	D, 1SS133T-72
D314	K000013300520	D, 1SS133T-72
D315	△ K000400700520	D, 1N4007
D316	△ K000400700520	D, 1N4007
D317	△ K000400700520	D, 1N4007
D318	△ K000400700520	D, 1N4007
D323	K000013300520	D, 1SS133T-72

ST-BY PCB ASSY [K]

REF. NO.	PARTS NO.	DESCRIPTION
DZ304	K06020R044520	D, ZENER MTZJ20B
DZ308	K06005R644520	D, ZENER MTZJ5. 6B
F300	△ N751224001110	FUSE, T4A 250V
F301	△ N751222501110	FUSE, T2. 5A 250V
GT304	3790040876010	TERMINAL, GND PLATE
GT305	3790040876010	TERMINAL, GND PLATE
IC300	△ J126780500400	IC, CJ7805F
IC302	△ J120001500030	IC, ICP-N15
JACK106	△ G435000160010	SOCKET, POWER RECEPTACLE
P300A	G645000050010	HOLDER, FUSE CLIP
P300B	G645000050010	HOLDER, FUSE CLIP
P301A	G645000050010	HOLDER, FUSE CLIP
P301B	G645000050010	HOLDER, FUSE CLIP
PT302	△ 8200280150210	POWER TRANS, STAND-BY 220V
Q300	J5021740S0010	TR, 2SC1740SR
Q302	J6020107M0010	TR, KRC107M
Q313	J5021740S0010	TR, 2SC1740SR
RLY304	△ G680090102010	RELAY, G5PA-1 DC9V

HP PCB ASSY [E,A,K]

REF. NO.	PARTS NO.	DESCRIPTION
	7028063236010	HP PCB ASSY [E, A, K]
JK201	G402038400031	JACK, D6. 5

HP PCB ASSY [CN]

REF. NO.	PARTS NO.	DESCRIPTION
	7028063236020	HP PCB ASSY [CN]
JK201	G402040161330	JACK, D6. 5

POWER SW PCB ASSY

REF. NO.	PARTS NO.	DESCRIPTION
	7028063234010	POWER SW PCB ASSY
SW701	△ G000122006060	SW, PUSH SDDL-005-S

ST-BY SW PCB ASSY

REF. NO.	PARTS NO.	DESCRIPTION
	7028063233010	ST-BY SW PCB ASSY
CP706	L101220020010	CN WAFER, G1L-S-2P-S2L2-EF
SW700	G180000270010	SW, TACT SKHV10920A

5 INCLUDED ACCESSORIES

INCLUDED ACCESSORIES

REF. NO.	PARTS NO.	DESCRIPTION	REMARKS
	5707211280050	OWNER'S MANUAL, EFS [E, A]	
	5707211280060	OWNER'S MANUAL, G1N [E]	
	5707211280080	OWNER'S MANUAL, E [CN, K]	
	8300426000010	REMOCON, UR-426	
	G670001R50220	BATTERY, DRY AAA	
	E605010010000	ANTENNA, WIRE DIPOLE	
	E605010090010	ANTENNA, AM LOOP	
	L109284007300	MATCHING TRANS [E, A, CN]	
	L109284007400	MATCHING TRANS [K]	